

Article number: 20561029

Description: E+G Steel-double cam lever
GN 917.1-8-13

Measures

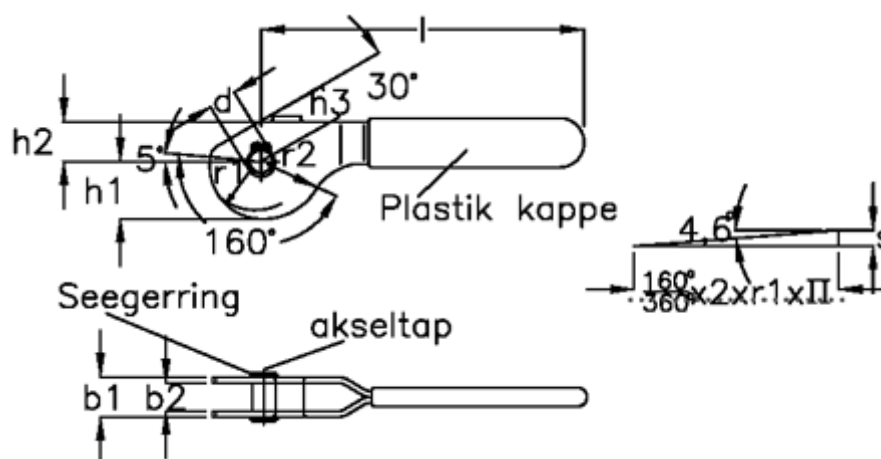

$B1 = 13$	$r2 = 21.07$
$B2 = 9$	$r2-h3 = 9.07$
$d = 8$	$s = 3.87$
$H1 = 19.54$	
$H2 = 14$	
$H3 = 12$	
$L = 114$	
$r1 = 17.2$	